

HPE Aruba Networking AP-ANT-348 antenna for indoor access points



Dual-polarized cabled tri-band 4-element high gain directional panel antenna (RP-SMA) for indoor and outdoor use

The AP-ANT-348 antenna is a tri-band, 4-element, dual-polarized panel antenna with nominal 60° H x 60° V beamwidths and 8dBi peak gain. This antenna is well suited for indoor and outdoor directional coverage for Wi-Fi access in 2.4GHz, 5GHz and/or 6GHz concurrently.

The AP-ANT-348 can be mounted directly to a wall (or ceiling) using the supplied screws and anchors, or if more flexibility is needed it can be combined with the optional AP-ANT-MNT-U articulating wall/pole mount.

Specifications

Frequency bands, ranges, and peak gains

2.4GHz	2.400GHz-2.500GHz	7.0dBi
5GHz	5.000GHz-5.875GHz	7.0dBi
6GHz	5.935GHz-7.150GHz	7.0dBi
	(6.0dBi above 7.0GHz)	

Polarization

Dual slant, ±45° x 2

Pattern beamwidth (3dB)

2.4GHz Elevation (V): 70 degrees (typ)
Azimuth (H): 70 degrees (typ)

5GHz Elevation (V): 56 degrees (typ)
Azimuth (H): 56 degrees (typ)

6GHz Elevation (V): 56 degrees (typ)
Azimuth (H): 56 degrees (typ)

Input impedance

50 Ohms

Maximum input power

2 Watts

VSWR

< 2.0:1

Port isolation

2.4GHz 20dB

5GHz 20dB

6GHz 20dB

Dimensions

190mm x 190mm x 40mm (antenna itself)

- An additional 11mm each side is required for antenna wall installation

263mm x 245mm x 78mm (as it ships)

Weight

1kg (antenna itself)

TBB (as it ships)

Radome

Material: Polycarbonate

Color: Grey-white (RAL-9002)

Fly cable length& type/connector

4x 750mm RF coaxial cable with RP-SMA male connector

Operating temperature range and relative humidity

-40°C to +85°C (temp)
5% to 95% RH (humidity)

Water and dust protection (IP rating)

IP67

Wind speed

220km/h (survival)160km/h (operation)

Lightning protection

DC grounded

Installation hardware

Ships with wall anchors

Optional AP-ANT-MNT-U adjustable wall/pole mount bracket purchased separately.

Shipping content

This antenna ships in a cardboard box

An installation guide hardcopy is included in the box

Antenna patterns (averaged for both antenna elements)

Horizontal (azimuth) plane (top view) & Vertical (elevation) plane (side view)

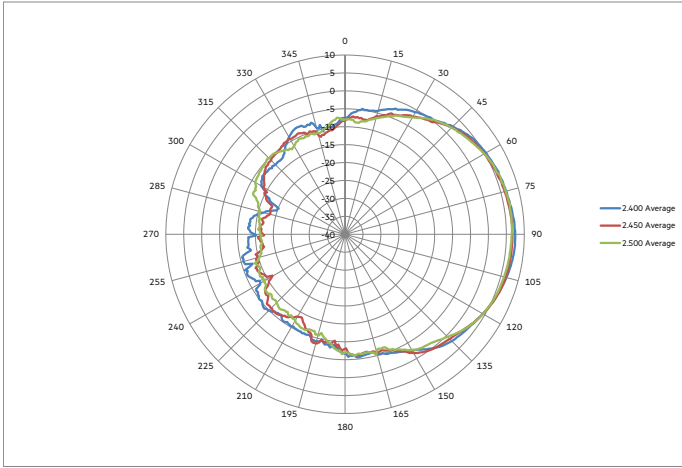

2.4GHz antenna patterns (horizontal)

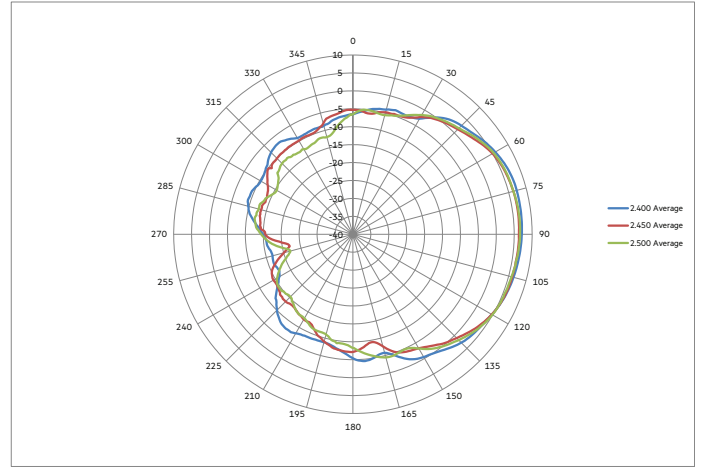

2.4GHz antenna patterns (vertical)

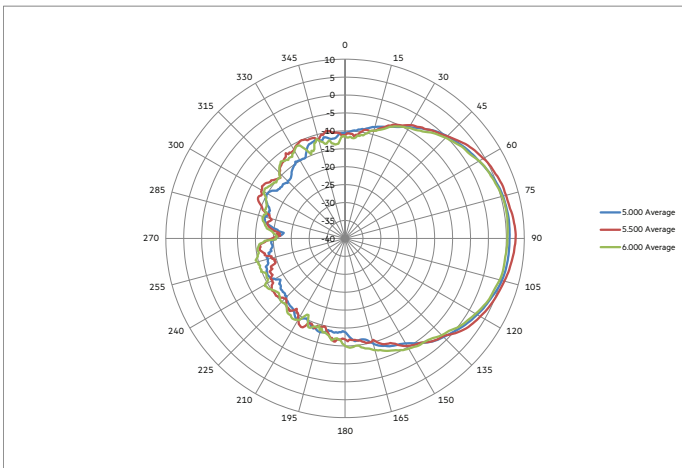

5GHz antenna patterns (horizontal)

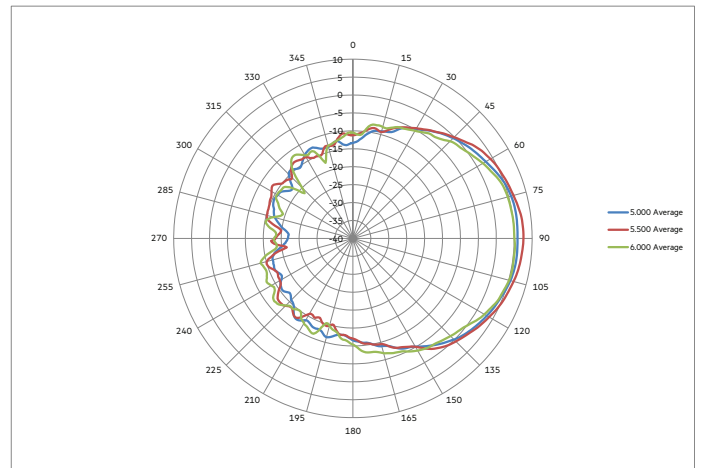

5GHz antenna patterns (vertical)

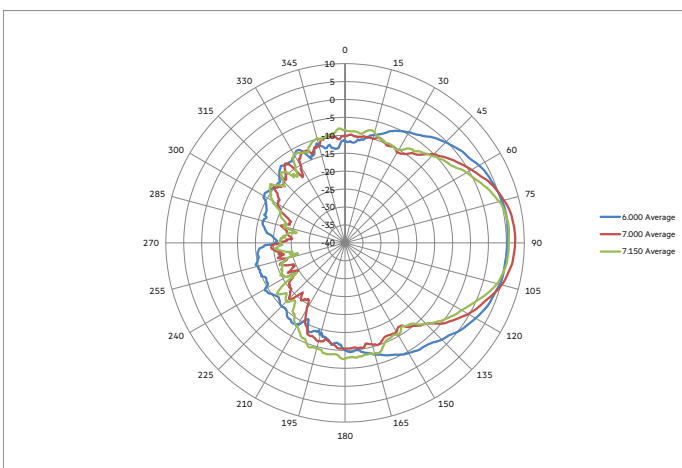

6GHz antenna patterns (horizontal)

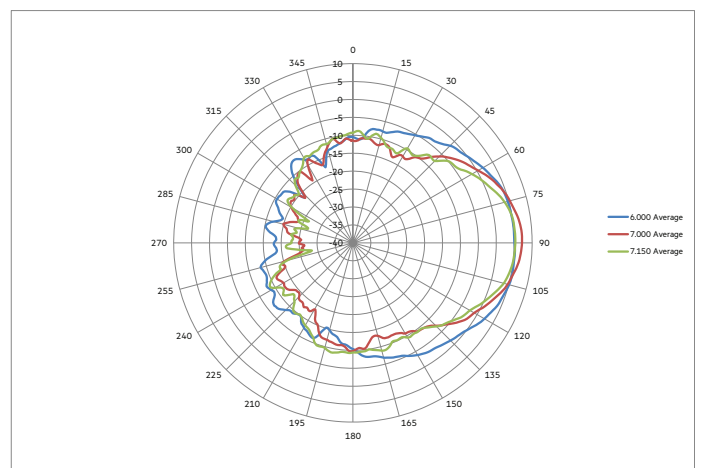

6GHz antenna patterns (vertical)



Mechanical drawings

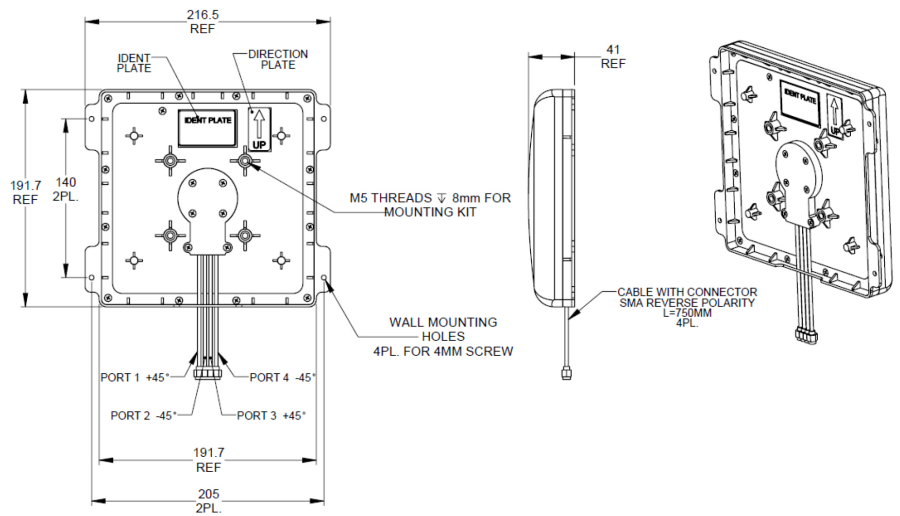

Ordering information

Part number	Description
HPE Aruba Networking Antennas for Indoor Access Points (RP-SMA)	
S1F84A	HPE Aruba Networking AP-ANT-348 Cabled RP-SMA Tri-Band 4x4 High Gain Directional Panel Antenna

Make the right purchase decision.
Contact our presales specialists.

